

2 1

B

B

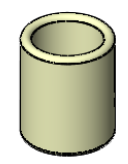
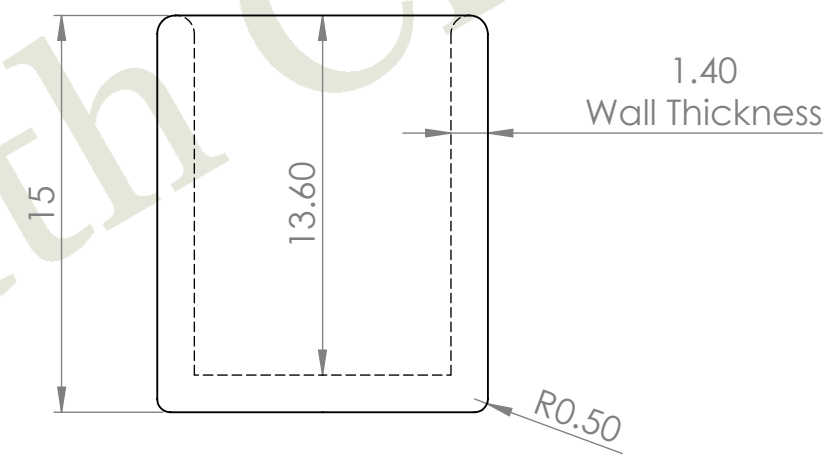
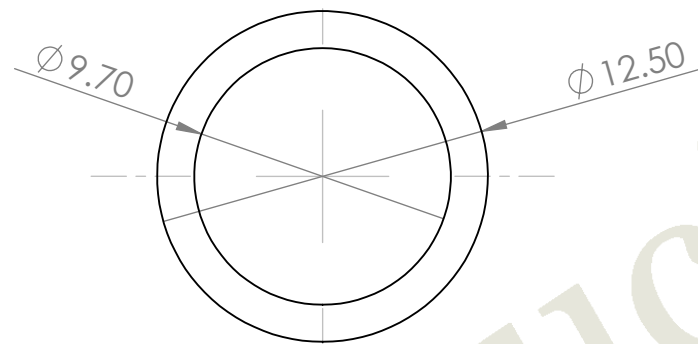

A

A

PROPRIETARY AND CONFIDENTIAL
THE INFORMATION CONTAINED IN THIS
DRAWING IS THE SOLE PROPERTY OF
ALMATH CRUCIBLES. ANY
REPRODUCTION IN PART OR AS A WHOLE
WITHOUT THE WRITTEN PERMISSION OF
ALMATH CRUCIBLES IS
PROHIBITED.

TOLERANCE GUIDE. DIN 40 680 MEDIUM		UNLESS OTHERWISE SPECIFIED: DIMENSIONS ARE IN MM		DRAWN	NAME	DATE	Almath Crucibles	
				CHECKED	DANNY	14/08/2018	ALMATH PRODUCT CODE:	
				ENG APPR.			CC9	
				MFG APPR.			SIZE DWG. REV	
				Q.A.			A STOCK	
				COMMENTS:			SCALE:3.5:1 SHEET 1 OF 1	
NEXT ASSY	USED ON	MATERIAL	FINISH					
APPLICATION		DO NOT SCALE DRAWING						

2

1